

Description and application:

Single leaf dampers are used to control the air flow in ventilation rectangular ducts . They are adapted for connection to ducts rectangular, standard equipped with mounting flanges with corners.

Type of drives :

- manual (PJ-AR)
- with actuator (PJ-AE)

Damper has Hygienic Certificate HK/K/0522/03/2016

Material and workmanship

The damper is made of galvanized steel. on request it is possible to make damper from stainless steel (type 1.4301 or 1.4404).

Size

The dampers are manufactured to order. The size of dampers are chosen according to dimension of ducts in which they are mounted.

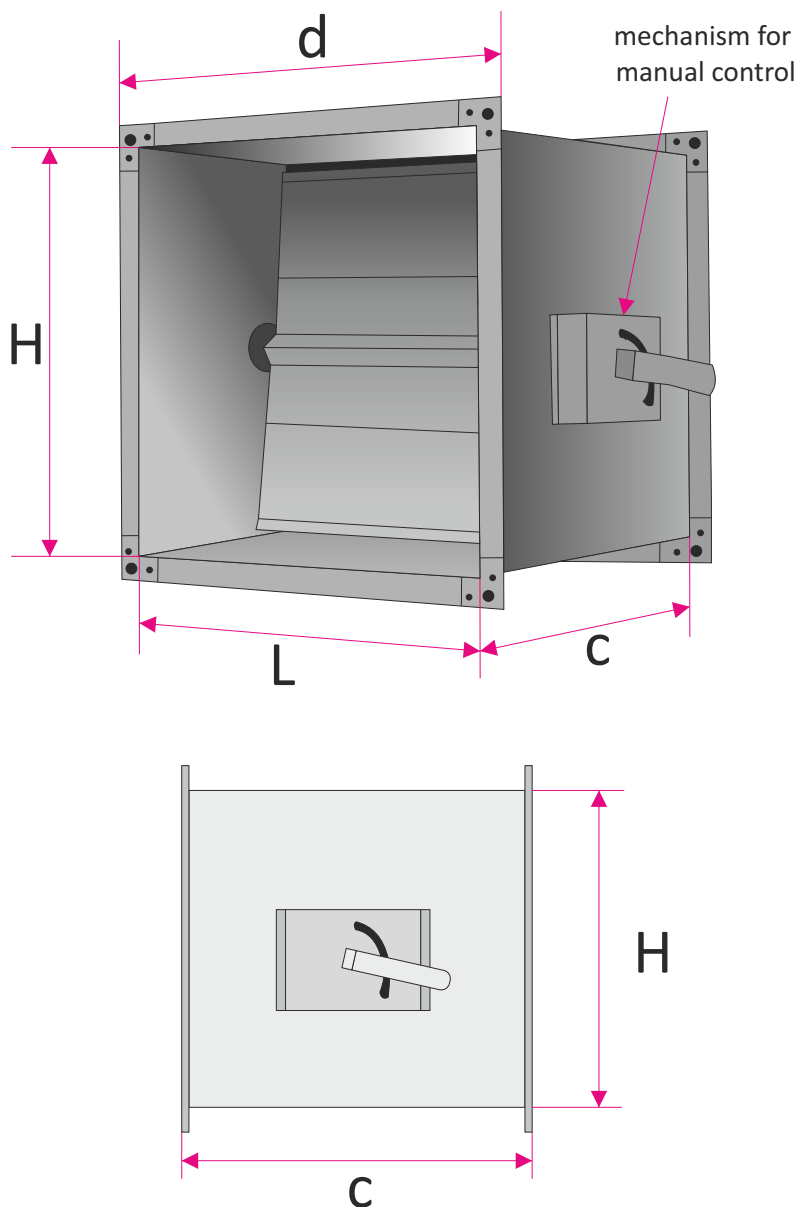

LxH	c	d
	mm	
100x100	200	140
160x160	200	200
100x200	200	140
160x200	200	200
200x200	200	240
200x250	200	240
250x250	200	290
200x400	200	240
250x400	200	290
400x400	250	440
250x500	200	290
400x500	250	440
500x500	250	540
400x800	300	440
500x800	300	540
800x800	300	860
500x1000	300	560
800x1000	300	860

Other dimensions on request.

Control methods

We offer two types of mechanism to control the damper:

- using manual mechanism (PJ-AR)
- using the actuator mechanism (PJ-AE)

PJ-AR - manual

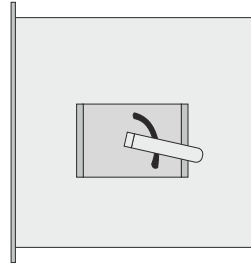

PJ-AE - using actuator

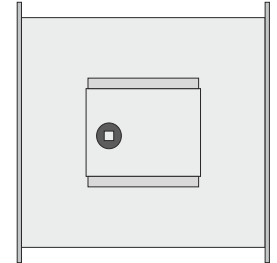

Technical data

Pressure drop and acoustic power depending on the efficiency and the angle of the damper

SYMBOL:

Q [m³/h] - air volume flow

ΔP [Pa] - pressure drop

v [m/s] - air speed in the duct

$\alpha=0^\circ$ damper in the open position

$\alpha=90^\circ$ damper in the closed position

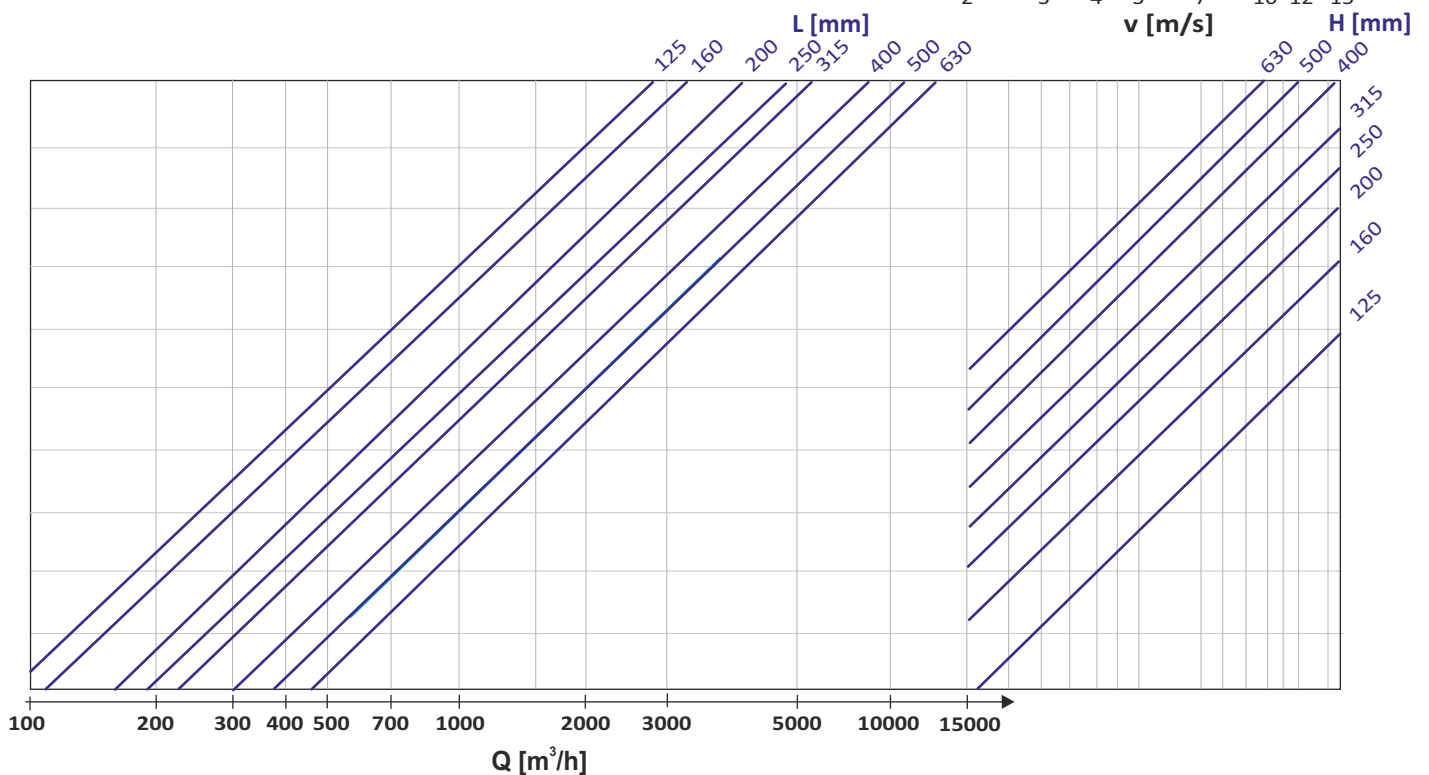
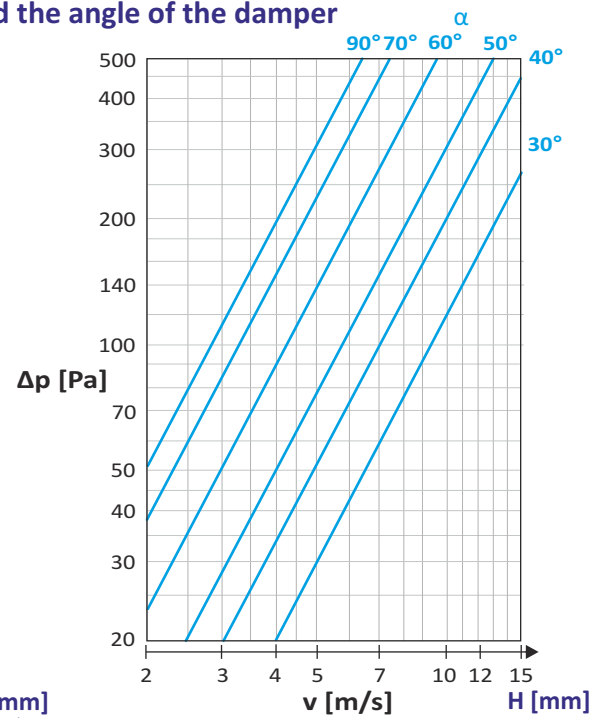
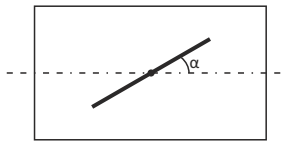

EXAMPLE

- size of damper PJ-A 400x250
- air volume flow $Q=1400 \text{ m}^3/\text{h}$
- the angle of the damper 45°

Reading from the graph:

- air speed in the duct $v=3,9 \text{ m/s}$
- pressure drop $\Delta p=40 \text{ Pa}$

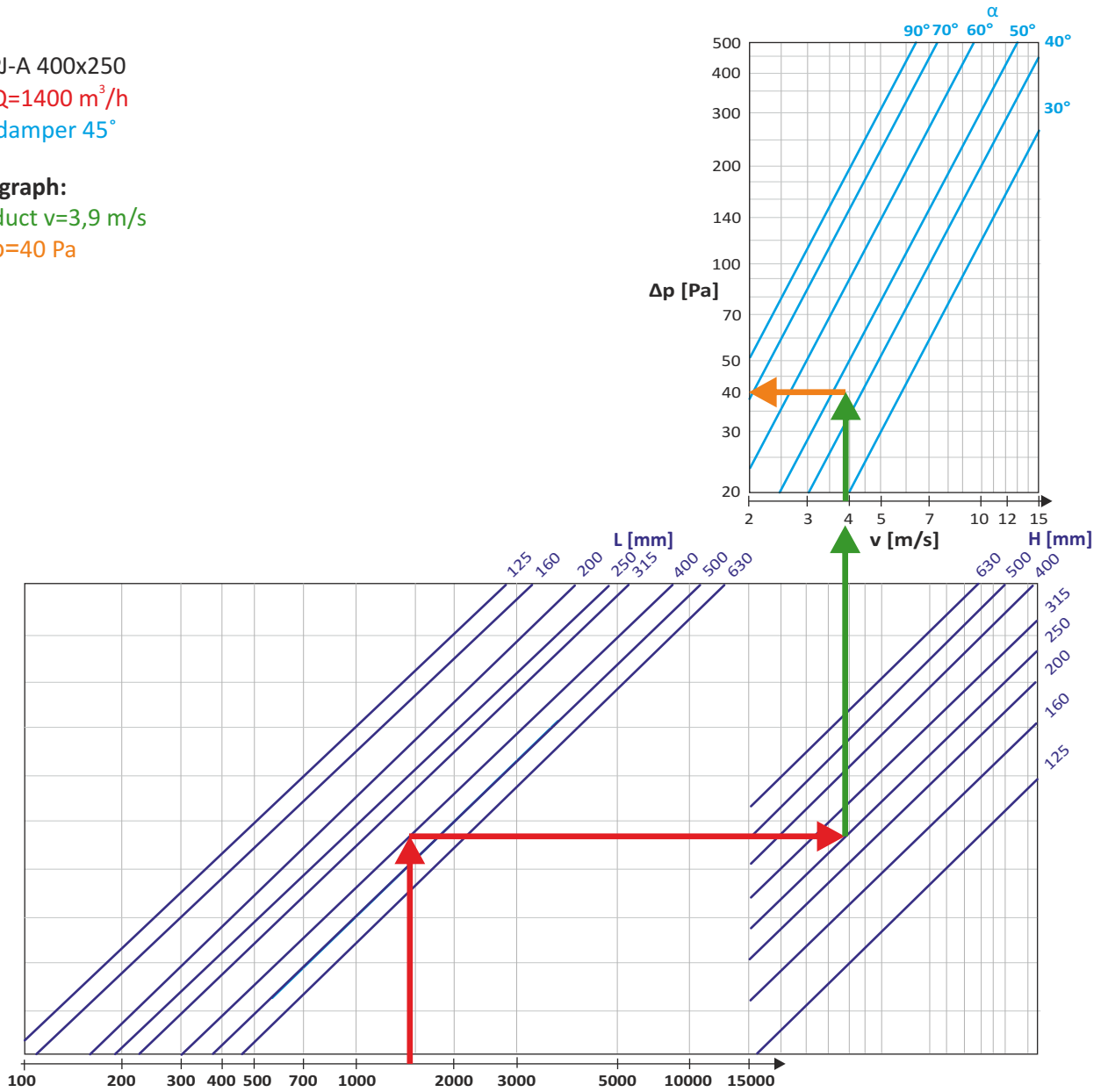

The method of placing an order

Please make orders according to the following formula:

Damper with manual control

PJ-AR / 'LxH' / 'M'

Damper with actuator control

PJ-AE / 'LxH' / 'M'

'LxH' - ventilation duct size in mm

'M' - material:

OC - galvanized steel*

KO - stainless steel / acid proof steel (type 1.4301 or 1.4404)

* - If you don't give the information will be used standard parameters.