

---

**ELECTRIC  
FAN HEATERS  
LEO EL BMS**



---

# TABLE OF CONTENT

■ GENERAL CHARACTERISTICS	3
■ CONSTRUCTION	4
■ DIMENSIONS	5
■ TECHNICAL DATA	5
■ RANGES	6
■ INSTALLATION AND VARIOUS MOUNTING POSSIBILITIES	7
■ REGULATION	9
■ CONTROL SYSTEMS	10
■ CONTROL ELEMENTS	11
■ BMS PROGRAMMING	12
■ FLOWAIR SYSTEM	12
■ CONNECTION DIAGRAMS	13
■ HEATING CAPACITIES	14

# GENERAL CHARACTERISTICS

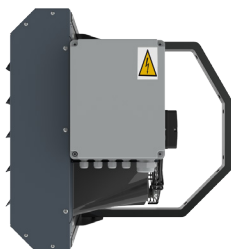

## Electric fan heater **LEO EL BMS**

Heating capacity [kW]	5,3 – 22,8
Air flow [m <sup>3</sup> /h]	1250 – 4250
Weight [kg]	19,7 – 27,8
Casing	steel
Colour	RAL 7016

## APPLICATION

LEO EL electric fan heaters are designed to operate indoors. They are used for heating rooms with a big cubic measure like industrial buildings, warehouses and department stores as well as smaller rooms like workshops or garages. Those heaters are commonly used in areas where other heat sources (e.g. gas, hot water) are not available.

## LEO EL BMS



---

# CONSTRUCTION

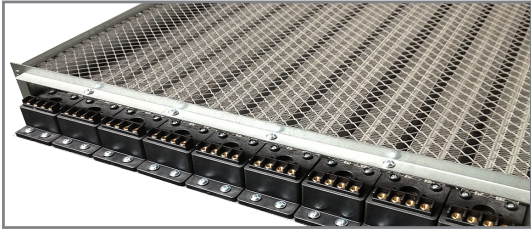

## HEATING ELEMENTS

The heater consists of PTC heating elements, which adapt temperature to the air flow. Their construction ensures maximum use of the heating capacity on each step of heating.



## CONTROL SYSTEM

The fan heater is equipped with complete power supply, control and protection automation. The unit has its independent system which protects against overheating. Additionally, the device can work with the BMS system and with the T-box controller.

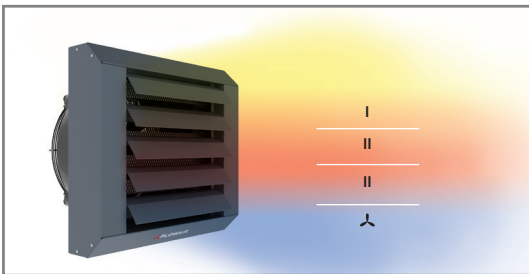

## THREE MODES

The device has 3 fans steps and 3 heating powers. It can also work in ventilation mode.

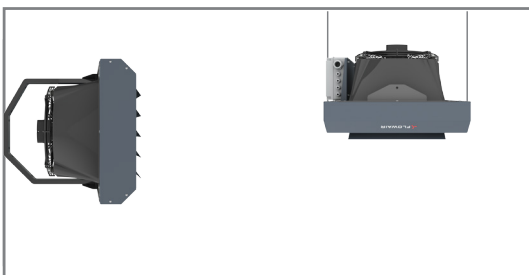

## INSTALLATION

LEO EL fan heaters can be mounted vertically on the wall or horizontally under the ceiling.

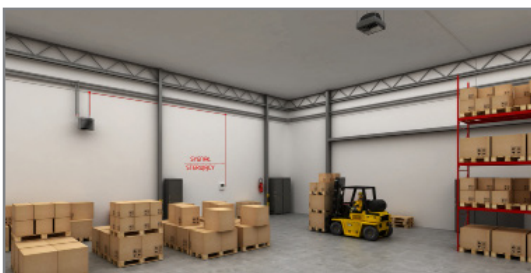

## AUTOMATIC DESTRATIFICATION

When installed under the ceiling, LEO EL BMS fan heaters with T-box controller offer automatic destratification function that relies on redirection of warm air from the upper zone of the room. When supported by fan heaters, it provides heating for large-cubature buildings.

# DIMENSIONS

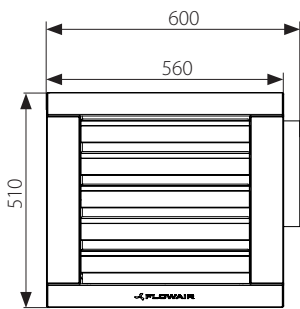

LEO EL S BMS

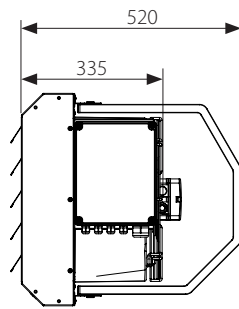

LEO EL L BMS

For CAD drawings and documentation for all available versions of LEO visit [www.flowair.com](http://www.flowair.com)



# TECHNICAL DATA

## Fan heater

### LEO EL BMS

#### LEO EL S BMS

#### LEO EL L BMS

	III	II	I	III	II	I
Step						
Max. airflow [m <sup>3</sup> /h]	2000	1600	1250	4250	2800	1700
Power supply [V/Hz]	3x400/50			3x400/50		
Max. current consumption [A]	0,6	0,4	0,3	1,4	1,2	0,6
Max. power consumption [W]	130	90	70	330	240	120
IP/Insulation class	54/F			54/F		
Max. acoustic pressure level [dB(A)] <sup>(1)</sup>	56,3	50,7	43,9	64,1	54,5	42,1
Max. acoustic power level <sup>(2)</sup>	71,4	65,8	59,0	79,2	69,6	57,2
Horizontal range <sup>(3)</sup> [m]	14,0	11,0	8,5	24,0	15,0	9,5
Vartical range <sup>(4)</sup> [m]	5,3	4,3	3,4	8,3	5,5	3,5
Max. operating temperature [°C]	50			50		
Weight of unit [kg]	19,7			27,8		

<sup>(1)</sup> acoustic pressure level at the distance of 5 m from the unit, in the room of medium capability of sound absorption and 1500 m<sup>3</sup> of cubature

<sup>(2)</sup> in accordance with PN-EN ISO3744

<sup>(3)</sup> range of horizontal isothermal air stream, at 0,5 m/s velocity limit

<sup>(4)</sup> range of vertical non-isothermal air stream at ΔT = 5°C, at 0,5 m/s velocity limit

# RANGES

## HORIZONTAL RANGE OF AIR STREAM – isothermal

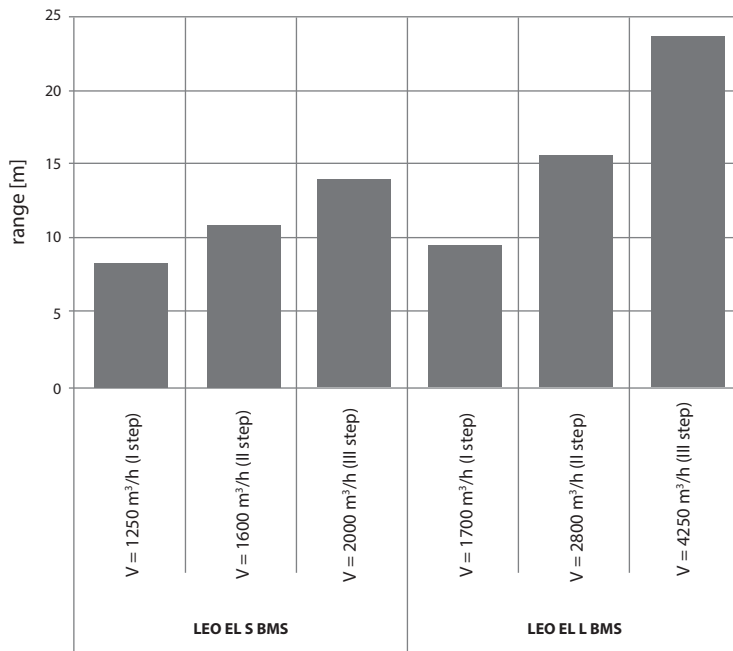

## VERTICAL RANGE OF AIR STREAM – non-isothermal

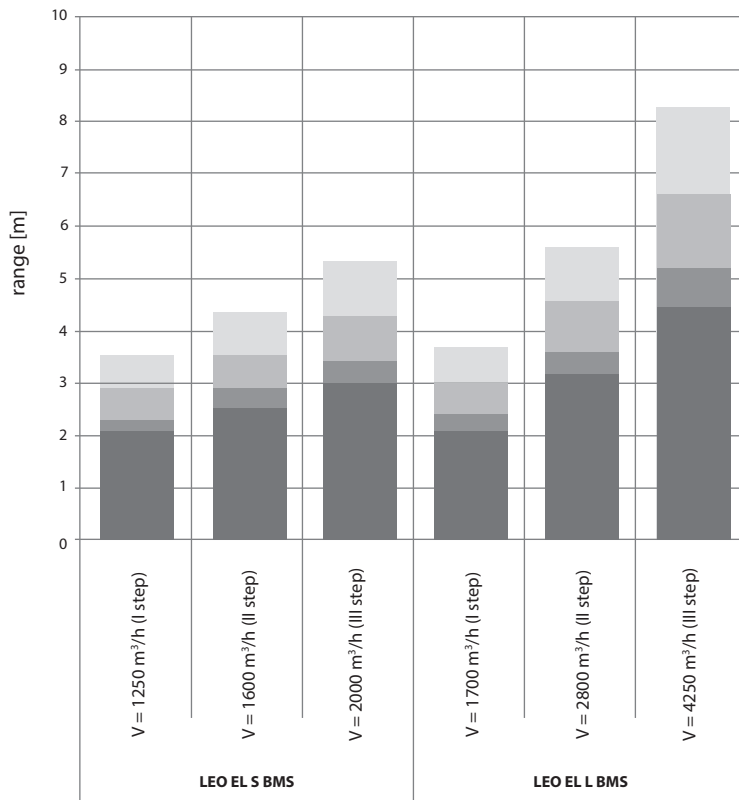

Δ5°C
  Δ10°C
  Δ20°C
  Δ30°C

# INSTALLATION AND VARIOUS MOUNTING POSSIBILITIES

installation under the ceiling

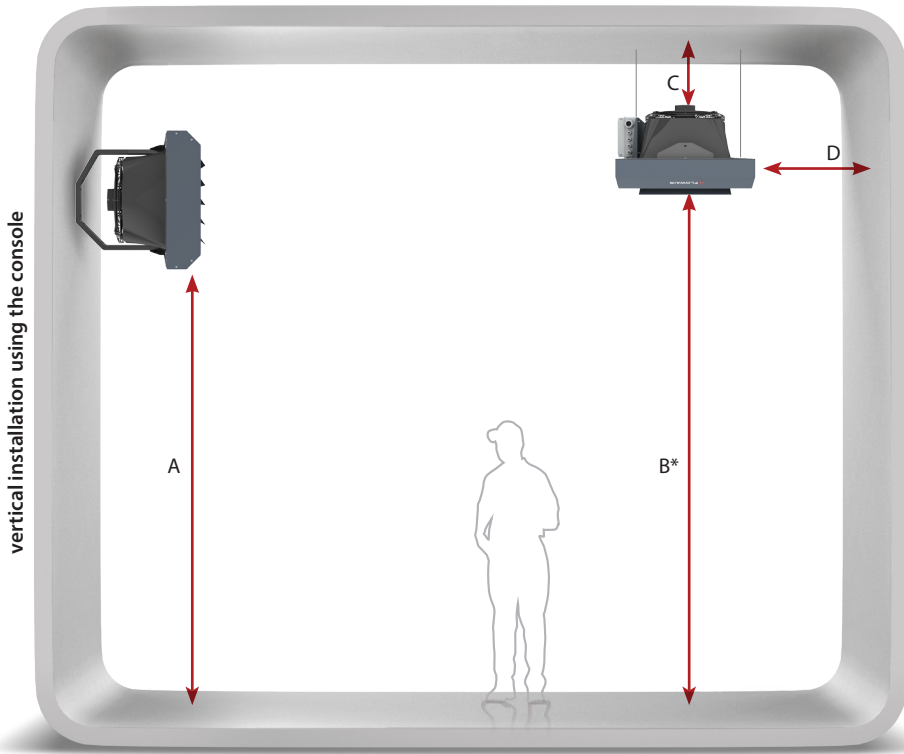

## Rotary console

It enables installation of the heater perpendicularly or horizontally at various angles to the partition.

\*\*When device is mounted under the ceiling please note the proper non-isothermal air stream range.

## I RECOMMENDED INSTALLATION DISTANCE [m]

	S	L
A	max. 3	max. 6
B	max. 6	max. 9,5
C	min. 0,2	min. 0,2
D	min. 0,5	min. 0,5

90°

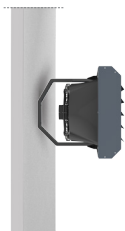

45°



30°

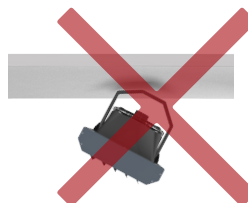
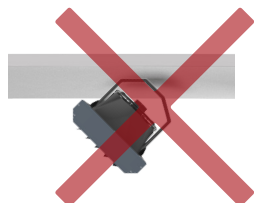
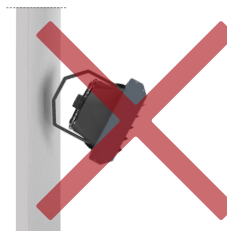

## I INSTALLATION TIPS

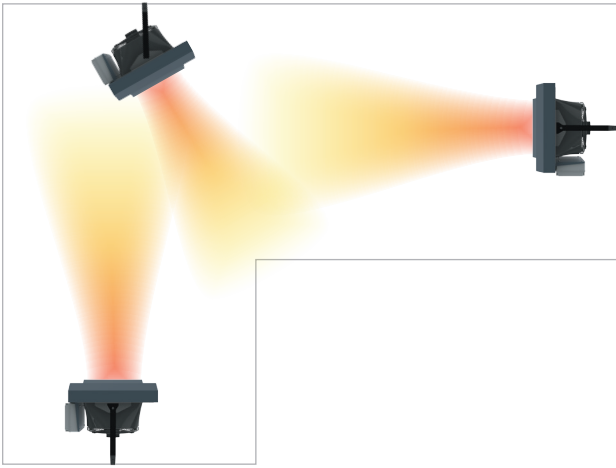

Steady air circulation should be provided in the entire room .

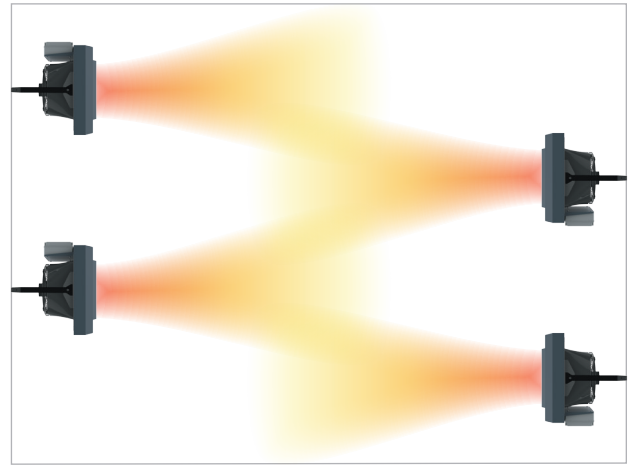

Heaters installed on the opposite walls should be overlapped.

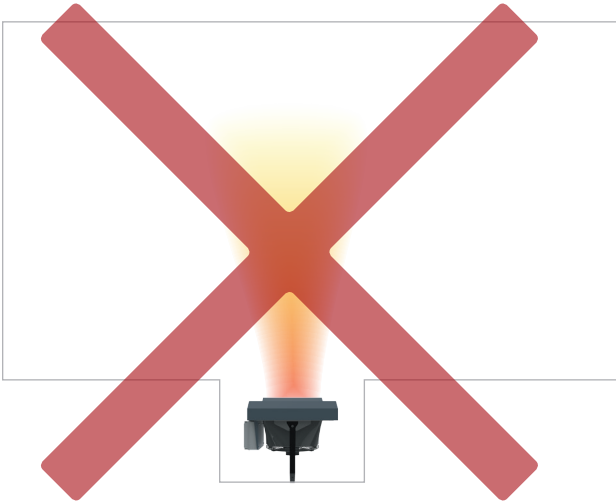

Air inlet should not be limited.

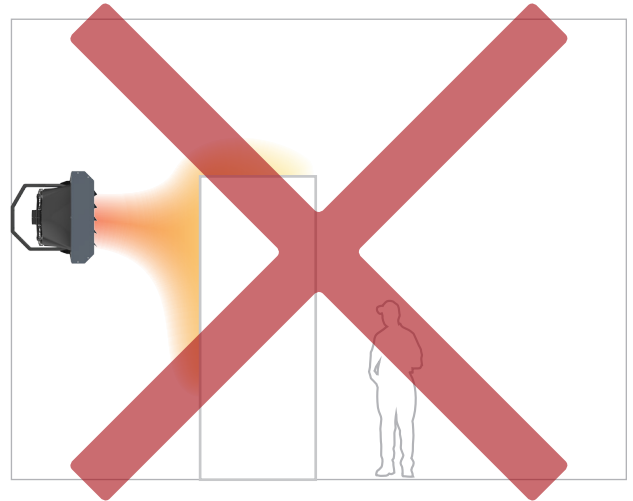

Air outlet should not be limited.



---

# REGULATION

The device is equipped with a complete set of power, control and protection automation. The fan and heaters have thermal protection, which interrupts the operation of the device in case of too high temperature.

The integrated DRV EL automation system enables regulation of the device using a T-box touch screen controller or a 3-steps TS thermostat.

## I T-box REGULATION FOR LEO EL BMS

LEO EL BMS fan heaters are equipped with an external DRV EL control module, which together with the T-box controller enables:

- 3-step manual fan speed regulation,
- 3-step manual heating power regulation,
- operating modes: heating, ventilation,
- 3-step automatic power and efficiency regulation in relation to the set temperature,
- fan operation in continuous airflow (depending on the set temperature, heating medium is cut off while fan is operating at selected step), or thermostatic mode (after reaching set temperature, heating medium is cut off and fan is turned off),
- antifreeze – automatic protection against too low temperature in the room,
- weekly programmer,
- integration with FLOWAIR SYSTEM.

### CONNECTING DEVICES:

The system is adapted to connect fan heaters and control up to 31 devices compatible with the FLOWAIR SYSTEM via single T-box controller.

### BMS:

The T-box controller or the DRV EL control module can be connected to the intelligent building management system BMS. This solution enables control of all devices communicating with the T-box controller and the DRV EL control module.

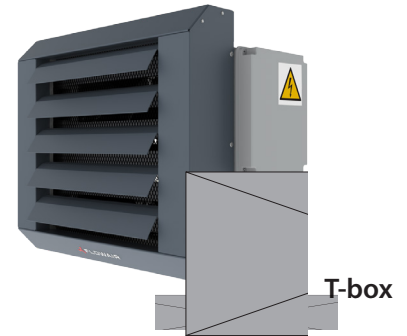

## I TS REGULATION FOR LEO EL BMS

This is the simplest LEO EL control system. The work of the fan heater is controlled by a 3-steps thermostat controlled regulator that allows:

- manual fan speed and power regulation (2 power levels and 2 speeds),
- operating modes: heating, ventilation,
- an operation in continuous mode (after reaching set temperature, heating medium is cut off while fan is operating at selected step), or thermostatic mode (after reaching set temperature, heating medium is cut off and fan is turned off).

### CONNECTING DEVICES:

One TS controller allows you to control one electric fan heater.

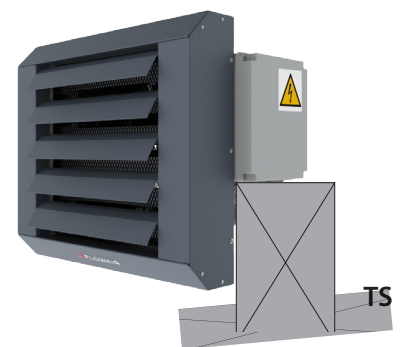

# CONTROL SYSTEMS

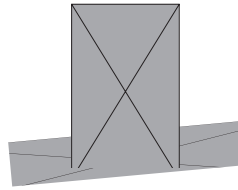

**TS CONTROLLER**  
basic version

the simplest regulation of 3-step fans. Fan heater operation is controlled by 3-step fan speed controller with thermostat.

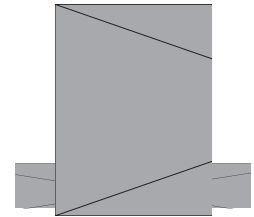

**T-box CONTROLLER**  
BMS version

the intelligent regulation system of 3-step fans. Speed regulation of energy-efficient fan via T-box controller.

## Electric fan heater LEO EL BMS



TS - controller



T-box - controller

### Types of regulation/control

Manual 3-step air flow regulation  
Automatic 3-step air flow regulation

### Modes

Heating / Ventilation  
Operation in continuous or thermostatic mode  
Weekly programmer  
BMS  
Integration with FLOWAIR SYSTEM  
Destratification mode



### Max. number of connected units

Via controller

Manual 3-step air flow regulation	✓	✓
Automatic 3-step air flow regulation		✓
Heating / Ventilation	✓	✓
Operation in continuous or thermostatic mode		✓
Weekly programmer		✓
BMS		✓
Integration with FLOWAIR SYSTEM		✓
Destratification mode		✓
Via controller	1	31

# CONTROL ELEMENTS

## T-BOX REGULATION FOR LEO EL BMS

Category	Symbol	Picture	Technical data
Controller	T-box intelligent controller with touch screen		Protection degree: IP20 Power supply: 24 VDC Temperature adjustment range: +5 ... +45°C Operating temperature range: 0 ... +60°C Max. wire diameter: 2,5 mm <sup>2</sup>
Temperature sensor	PT-1000 IP65 wall-mounted temperature sensor IP65		Protection degree: IP65 Operating temperature range: -20 ... +80°C Max. wire diameter: 1,5 mm <sup>2</sup>

## TS REGULATION FOR LEO EL BMS

Category	Symbol	Picture	Technical data
Thermostat	TS 3-step fan speed regulator with thermostat		Protection degree: IP30 Power supply: 230V/50Hz Temperature adjustment range: +10 ... +30°C Operating temperature range: 0 ... +40°C Contacts load: 5 A Max. wire diameter: 1,5 mm <sup>2</sup>

# BMS PROGRAMMING

## FOR T-box REGULATION

Connection of devices to the BMS (Building Management System) is possible in two ways: through the T-box controller (Version 1) or through the DRV control module (Version 2).

### VERSION 1

T-box and HMI controllers enable connection of the system to BMS system (Building Management System). When monitoring devices via the T-box controller with one address in the BMS, it is possible to independently monitor the operation of up to 31 devices.

#### Communication parameters:

Name	T-box regulation
Physical layer	RS485
Protocol	MODBUS-RTU
Transmission speed [bps]	9600 to 230400
Parity	Even
Number of data bits	8
Number of stop bits	1

### VERSION 2

The DRV EL control modules enable connection to the BMS system. It is possible to set up to 31 addresses. Setting the address for each device separately allows independent reading and saving of the work parameters of each device.

#### Communication parameters:

Name	DRV EL
Physical layer	RS485
Protocol	MODBUS-RTU
Transmission speed [bps]	38400
Parity	Even
Number of data bits	8
Number of stop bits	1

# FLOWAIR SYSTEM

FLOWAIR SYSTEM is an intelligent solution which makes it possible to integrate the devices into a system with only one controller. T-box offers many functions necessary for effective management of a heating-ventilating system. These functions were previously reserved for an extensive Building Management System (BMS).

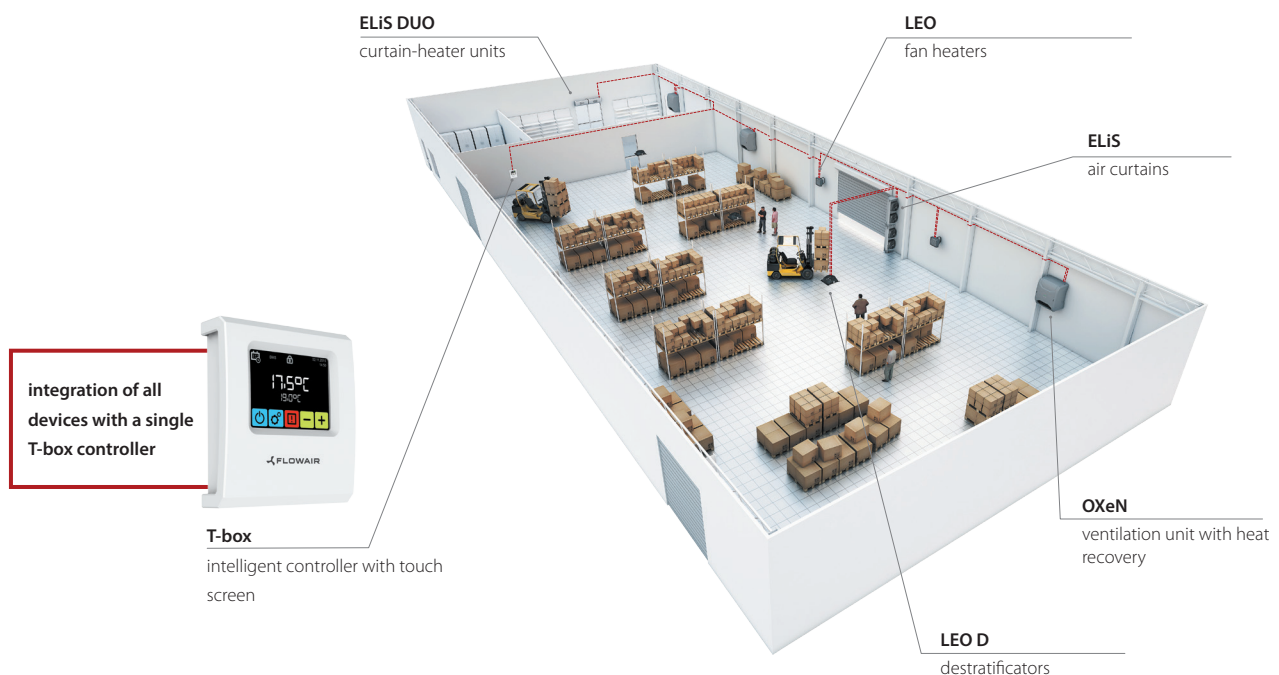

# CONNECTION DIAGRAMS

## LEO EL BMS REGULATION WITH T-box CONTROLLER

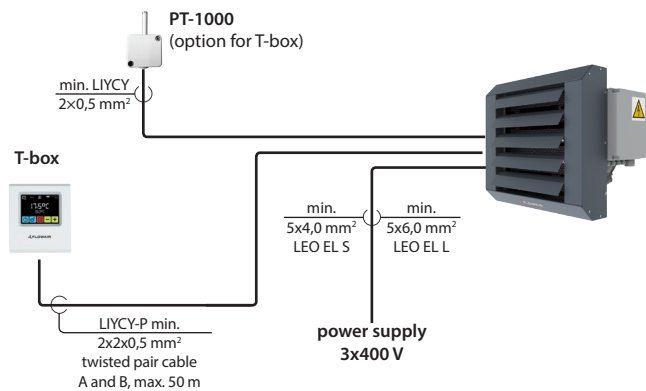

## LEO EL BMS REGULATION WITH TS CONTROLLER

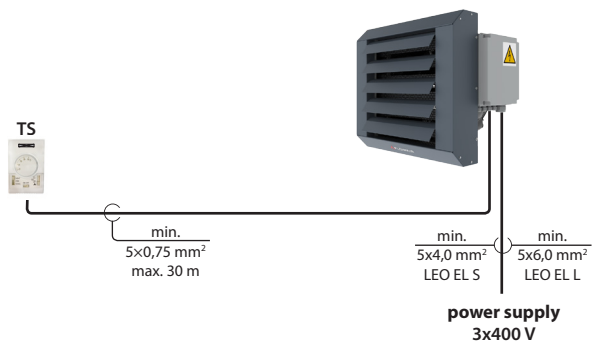

Max. diameter of thermostat cable TS 1,5 mm<sup>2</sup>.

Max. diameter of supplying cable 10 mm<sup>2</sup>.

# HEATING CAPACITIES

1 <sup>st</sup> step of heating				2 <sup>nd</sup> step of heating			
Tp1	PT	PC	Tp2	Tp1	PT	PC	Tp2
°C	kW	A	°C	°C	kW	A	°C
<b>LEO EL S BMS</b>							

III step: V = 2000 m <sup>3</sup> /h							
0,0	6,0	8,6	9	0,0	10,8	15,6	19
10,0	5,9	8,4	17	10,0	10,3	14,8	24
20,0	5,8	8,3	26	20,0	10	14,4	30
II step: V = 1600 m <sup>3</sup> /h							
0,0	5,9	8,5	10	0,0	10,2	14,7	25
10,0	5,7	8,2	19	10,0	9,8	14,0	29
20,0	5,5	8,0	28	20,0	9,6	13,8	34
I step: V = 1250 m <sup>3</sup> /h							
0,0	5,5	7,9	15	0,0	9,5	13,6	28
10,0	5,4	7,8	22	10,0	9,2	13,2	32
20,0	5,3	7,7	30	20,0	8,9	12,8	38

1 <sup>st</sup> step of heating				2 <sup>nd</sup> step of heating				3 <sup>rd</sup> step of heating			
Tp1	PT	PC	Tp2	Tp1	PT	PC	Tp2	Tp1	PT	PC	Tp2
°C	kW	A	°C	°C	kW	A	°C	°C	kW	A	°C
<b>LEO EL L BMS</b>											

III step: V = 4250 m <sup>3</sup> /h											
0,0	8,8	12,5	6	0,0	16,3	23,3	14	0,0	22,8	33,3	18
10,0	8,3	11,9	15	10,0	15,4	22,2	21	10,0	21,2	31,0	26
20,0	8,0	11,4	24	20,0	14,7	21,2	28	20,0	20,6	30,1	34
II step: V = 2800 m <sup>3</sup> /h											
0,0	8,1	11,6	8	0,0	15,1	21,4	19	0,0	20,3	29,2	24
10,0	7,8	11,1	17	10,0	14,2	20,5	24	10,0	19,6	28,0	30
20,0	7,6	10,8	26	20,0	13,7	19,9	30	20,0	19,1	27,5	38
I step: V = 1700 m <sup>3</sup> /h											
0,0	7,5	10,6	11	0,0	13,7	19,3	24	0,0	18,0	26,0	29
10,0	7,1	10,1	20	10,0	13,0	18,6	27	10,0	17,2	24,5	36
20,0	6,8	9,8	29	20,0	12,4	17,8	33	20,0	16,6	24,0	44

V – air flow  
 PT – heating capacity  
 PC – power consumption  
 Tp1 – inlet air temperature  
 Tp2 – outlet air temperature

---

# NOTES



ul. Chwaszczyńska 135  
81-571 Gdynia, Poland

T +48 58 627 57 20

for inquiries:  
[info@flowair.pl](mailto:info@flowair.pl)  
[www.flowair.com](http://www.flowair.com)

